

TEINA KOM2D4S

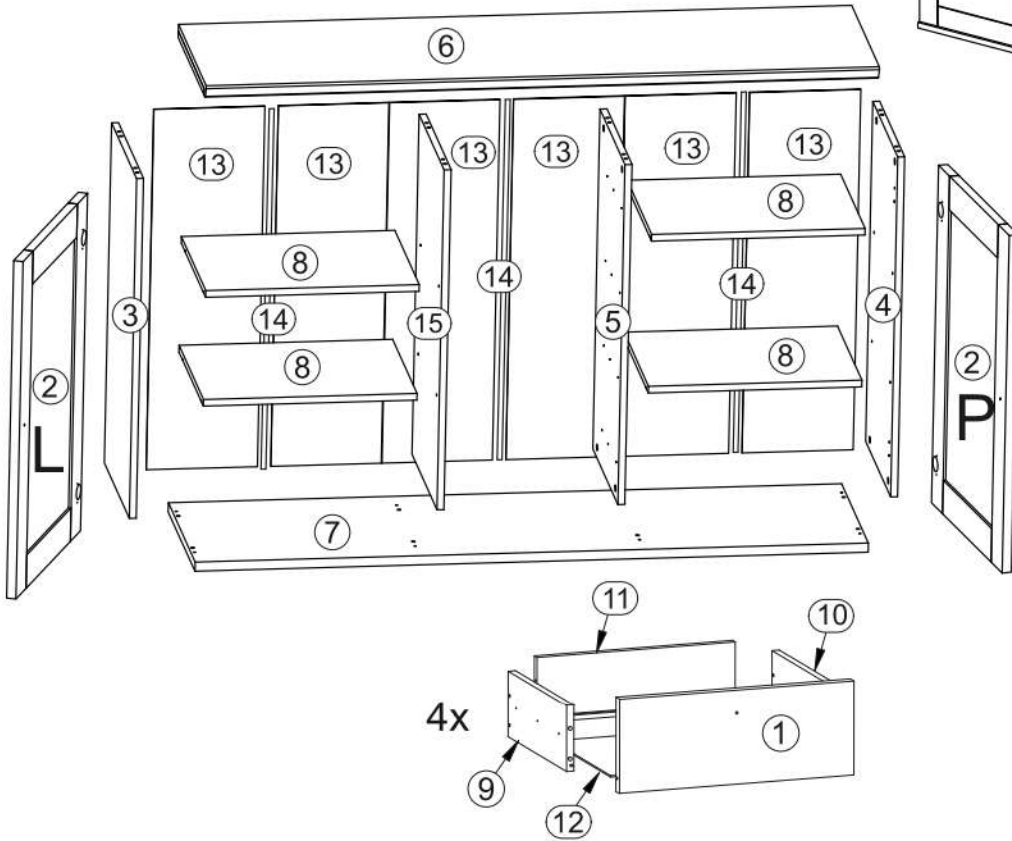

A	B	C	D
1	S239-0025	511	200
2	S239-0008	809	511
3	S239-1026	815	392
4	S239-1015	815	392
5	S239-1016-01	815	392
6	S239-2018	1545	435
7	S239-2019	1545	421

A	B	C	D
8	S239-3004	490	382
9	WSQ4-505-01	350	140
10	WSQ4-506-01	350	140
11	WTQ-5072	441	140
12	S239-9070	456	349
13	S239-9504	864	255
14	LH-830	830	14
15	S239-1025	815	392

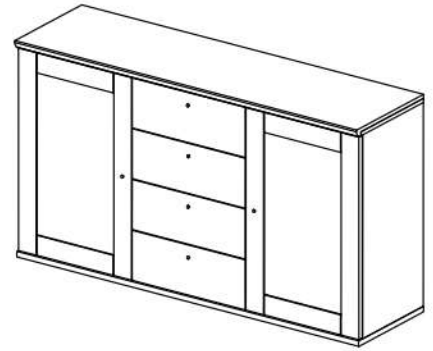
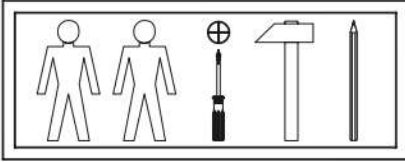
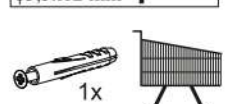
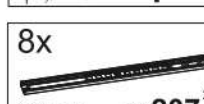
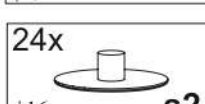
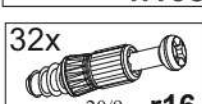
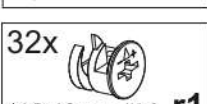
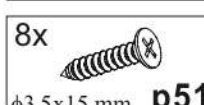
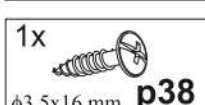
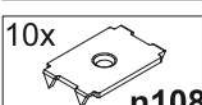
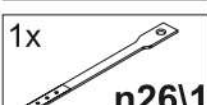
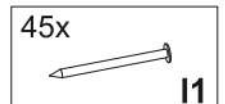
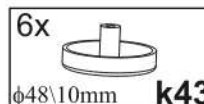
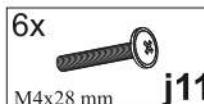
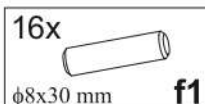
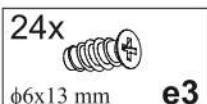
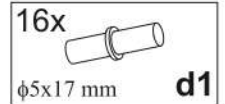
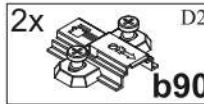
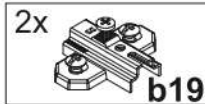
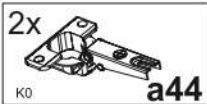

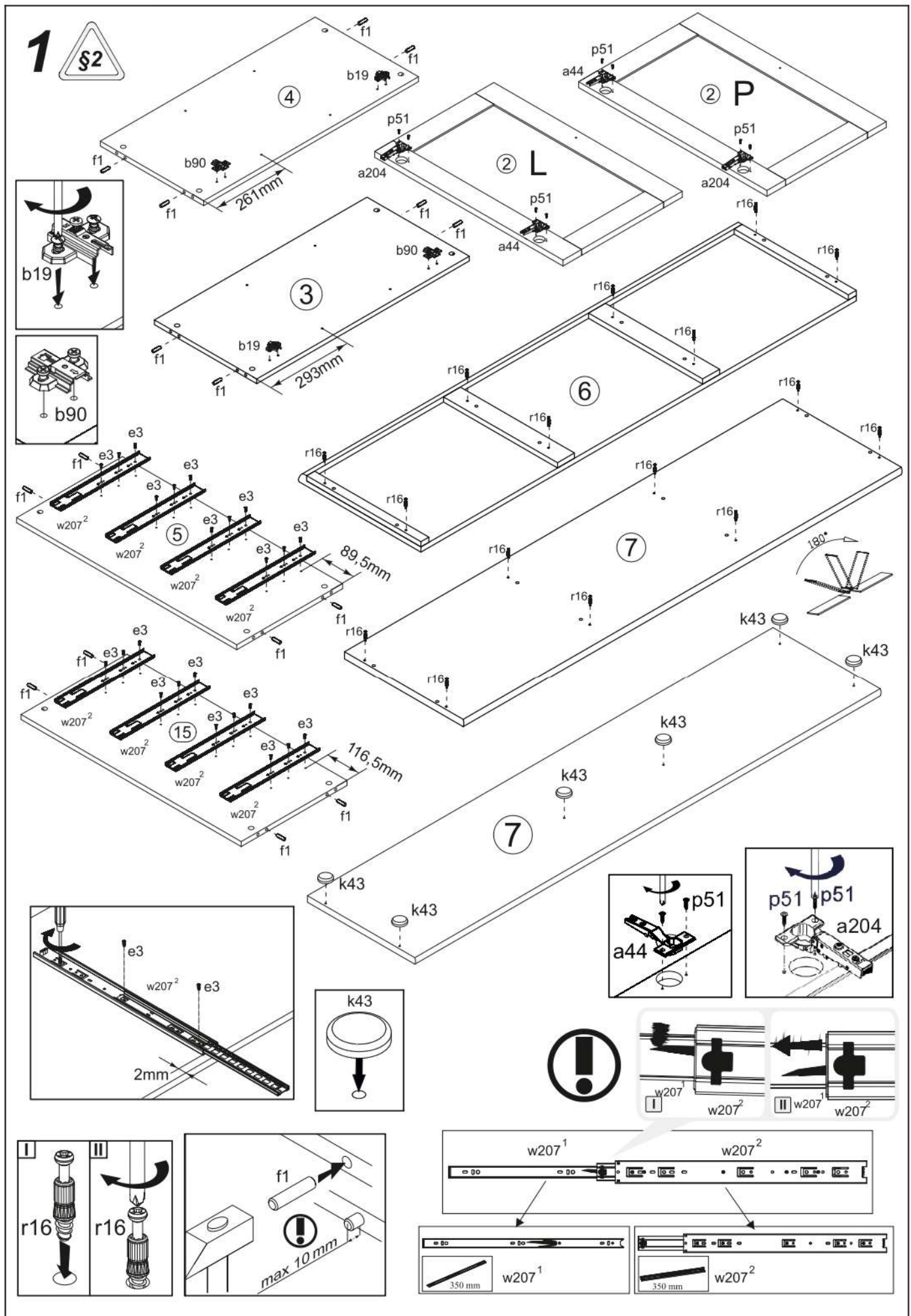

2 

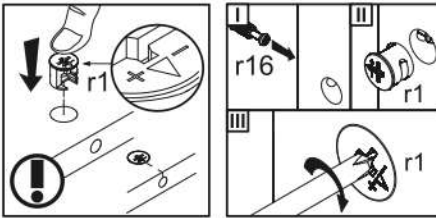
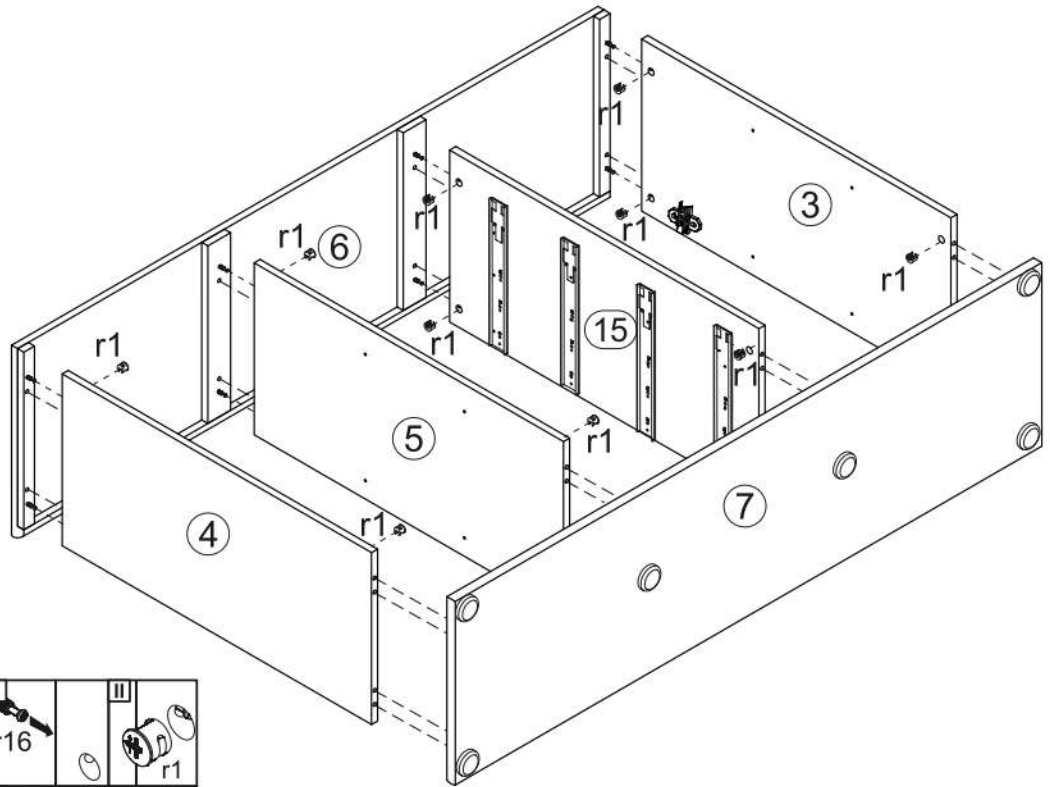

3

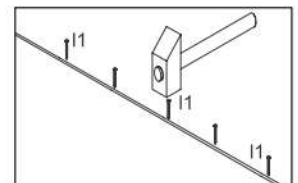
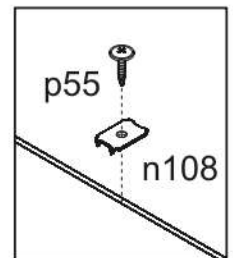
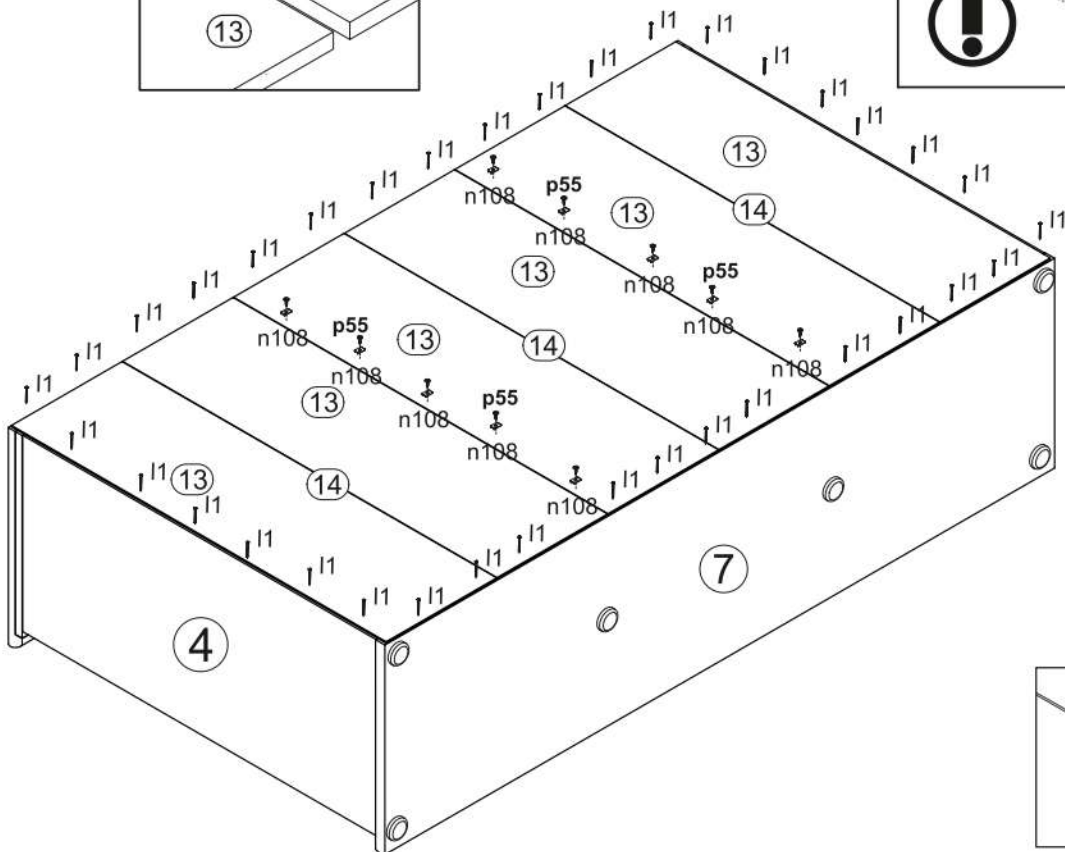
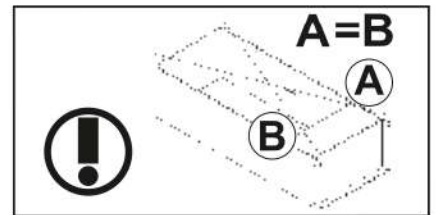
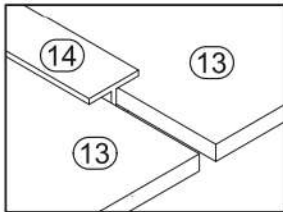

4

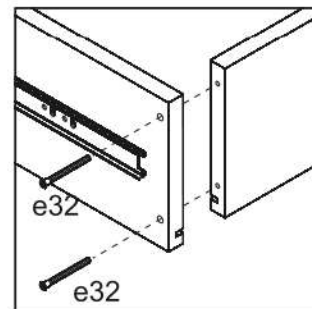
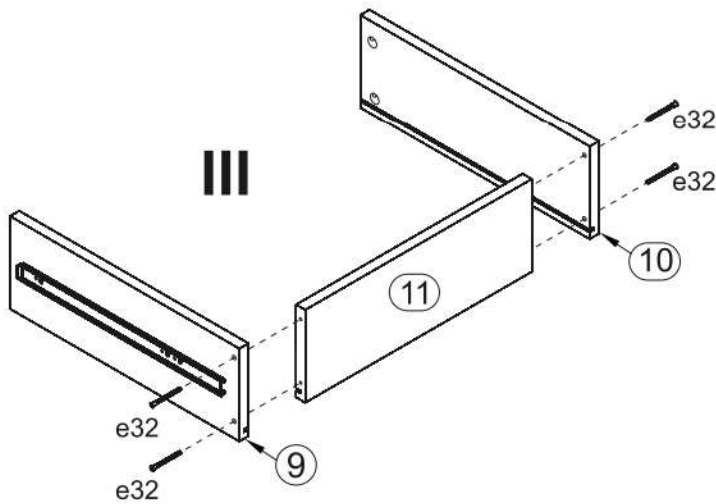
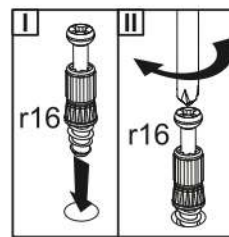
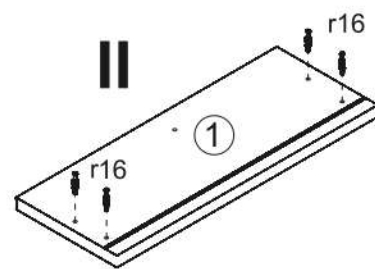
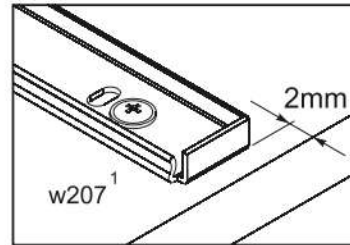
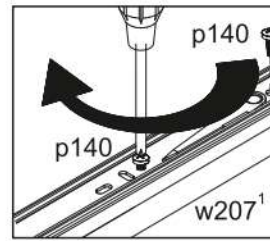
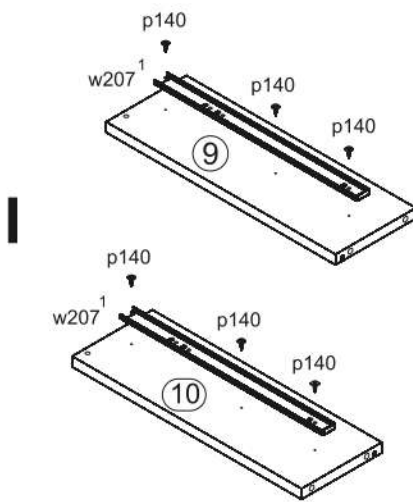

IV

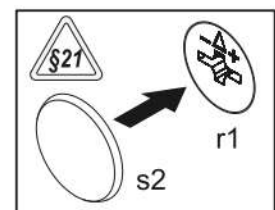
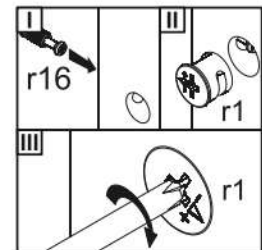
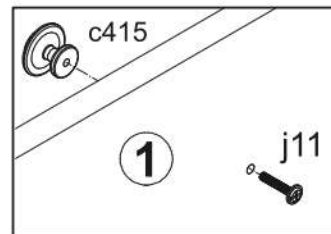
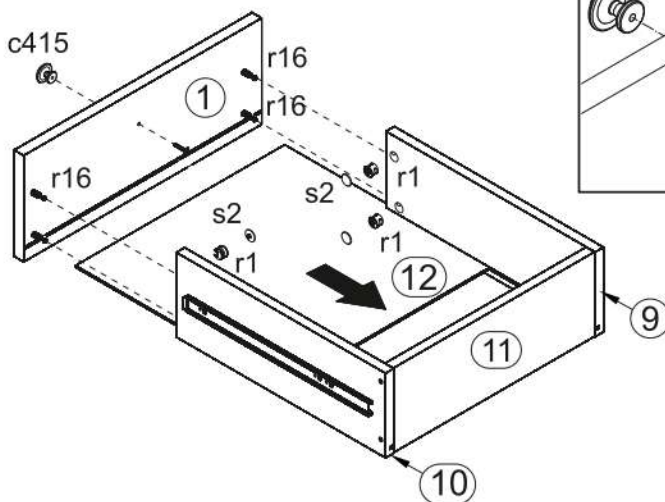

5

